

Rimin Track Lights

ITEM SKU#: 662187490878

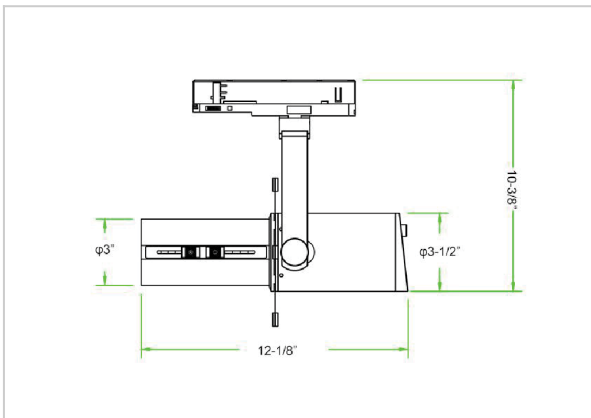

Product Code : IK-RRIMINTL-20W-35K-BL-90C-ADB

Voltage	100 - 277 V AC, 50-60 Hz
Lumen Output	1543.5lm
Power	20W
Efficacy	140lm/w
CCT	3500K
CRI	>90
Beam Angle	60°
Light Distribution	Flood
LED Light Source	Osram SOLERIQ S 19
Start Time	Instant
Driver	Stand Alone (included)
Operating Position	Swiveling Type
Dimming	Triac Dimming, Local Dimming
Construction	Track
Mounting Type	Track Light Structure
Heads	Single Head
Finish	Black
Height	10-3/8"
Diameter	3"
Width (W)	12-1/8"
Application Area	Indoor Applications

Shapes (Narrow, Wide, Round, Square, and Other Shapes)

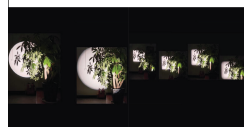

Rimin Projector Light is a versatile lighting solution designed for adaptability, aesthetics, and dynamic projection capabilities. It is 15° to 60° adjustable, which empowers you with tailored, precise illumination. In addition, the projection can be done in various shapes, such as round and square, allowing you to effortlessly create captivating visual displays.



Technical Data

[Installation Instructions Link](#) ↓