

Ork Track Lights

ITEM SKU#: 662187490465

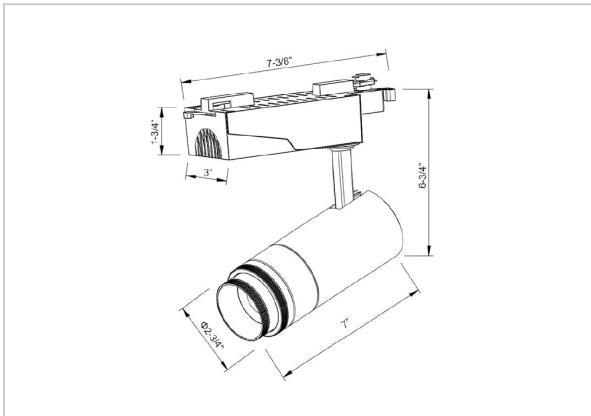

Product Code : IK-RORKTL-20W-40K-BL-90C-ADB

Voltage	100 - 277 V AC, 50-60 Hz
Lumen Output	2800lm
Power	20W
Efficacy	140lm/w
CCT	4000K
CRI	>90
Beam Angle	15°
Light Distribution	Wide flood
LED Type	COB
LED Light Source	Osram SOLERIQ S 19
Start Time	Instant
Driver	Stand Alone (included)
Operating Position	Swiveling Type
Dimming	Triac Dimming
Construction	Track
Mounting Type	Track Light Structure
Heads	Single Head
Body Material	Aluminium Die cast
Finish	Black
Length	6-1/4"
Height	7-1/4"
Diameter	2-1/2"
Cut Out	7-3/8"
Width (W)	7-3/8"
Application Area	Indoor Applications



Beam Spread (Options)

Spot	15°	Medium	24°	Flood	36°	Wide Flood	60°
ft	Ø	ft	Ø	ft	Ø	ft	Ø
3.0	0.72	3.0	1.41	3.0	2.03	3.0	3.15
9.0	2.15	9.0	4.22	9.0	6.09	9.0	9.45
15.0	3.58	15.0	7.04	15.0	10.15	15.0	15.75

Ork is a technologically advanced LED track light with incorporated electronic gear and chip on board. It also has a high-quality reflector with three different beam spreads. Moreover, the lamp housing of die-cast aluminum for optimal cooling allows the fixture to last longer than its traditional counterparts.

Technical Data

[IES File Link](#) ↓