

# Scint Down Lights

ITEM SKU#: 662187499864

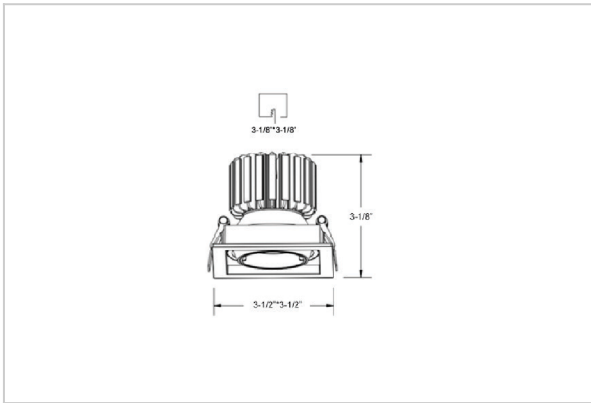

## Product Code : IK-RSCINTDL-12W-27K-WH-90C-36D

Voltage	100 - 277 V AC, 50-60 Hz
Lumen Output	1080lm
Power	12W
Efficacy	90lm/w
CCT	2700K
CRI	>90
Beam Angle	36°
Light Distribution	Flood
LED Light Source	Osram SOLERIQ S 19
Start Time	Instant
Driver	Stand Alone (included)
Operating Position	Swiveling Type, 360D
Dimming	On-Off / Triac / 0-10 V
Construction	Sqaure
Mounting Type	Recessed
Heads	Single Head
Body Material	Aluminium Die cast
Finish	White
Height	3-1/8"
Diameter	3-1/2"x3-1/2"
Cut Out	3-1/8"x3-1/8"
Optics	Darklight Technology Black, Silver
Application Area	Guest Room, Corridor, Restaurant, Meeting Room Club, Hall, Hotel Entrance



### Beam Spread (Options)

Spot 15°		Medium 24°		Flood 38°	
ft	Ø	ft	Ø	ft	Ø
3.0	0.72	3.0	1.41	3.0	2.03
9.0	2.15	9.0	4.22	9.0	6.09
15.0	3.58	15.0	7.04	15.0	10.15

Square in design, Scint LED downlight is made up of aluminum die cast with high quality powder coated luminaire housing and optimum heat sink. Available in multiple wattages and beam angle, the luminaire renders greater flexibility in its application for store lighting. Moreover, the specular darklight reflector in this store light allows outstanding visual comfort to the visitors.