

Glint Down Lights

ITEM SKU#: 662187494845

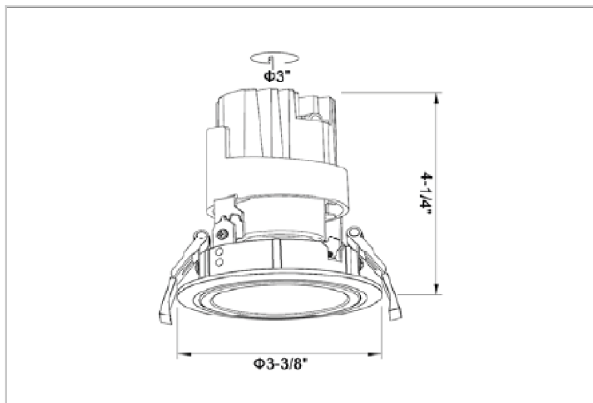

Product Code : IK-RGLINTDL-8W-35K-WH-90C-15D

Voltage	100 - 277 V AC, 50-60 Hz
Lumen Output	680lm
Power	8W
Efficacy	85lm/w
CCT	3500K
CRI	>90
Beam Angle	15°
Light Distribution	Spot
LED Type	COB
LED Light Source	Osram SOLERIQ S 19
Start Time	Instant
Driver	Stand Alone (included)
Operating Position	Swiveling Type
Dimming	On-Off / Triac / 0-10 V
Construction	Round
Mounting Type	Recessed
Heads	Single Head
Body Material	Aluminium Die cast
Finish	White
Height	4-1/4"
Diameter	3-3/8"
Cut Out	3"
Optics	Darklight Technology Black, Silver
Application Area	Guest Room, Corridor, Restaurant, Meeting Room Club, Hall, Hotel Entrance



Beam Spread (Options)

Spot 15°		Medium 24°		Flood 38°	
ft	Ø	ft	Ø	ft	Ø
3.0	0.72	3.0	1.41	3.0	2.03
9.0	2.15	9.0	4.22	9.0	6.09
15.0	3.58	15.0	7.04	15.0	10.15

Glint, a circular shaped LED downlight made of aluminum die cast with high quality powder coated luminaire housing and optimum heat sink. Specular reflector & power grid / global connectors available with isolated LED Driver using Ultra bright OSRAM COB.