

Glim Down Lights

ITEM SKU#: 662187494333

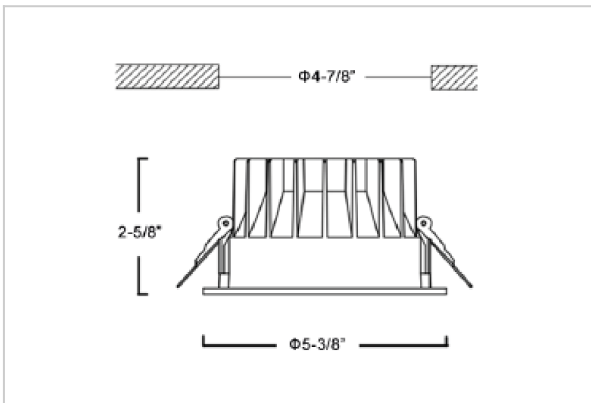

Product Code : IK-RGLIMDL-15W-35K-WH-90C-60D

| | |
|--------------------|------------------------------------|
| Voltage | 100 - 277 V AC, 50-60 Hz |
| Lumen Output | 1350lm |
| Power | 15W |
| Efficacy | 90lm/w |
| CCT | 3500K |
| CRI | >90 |
| Beam Angle | 60° |
| Light Distribution | Wide flood |
| LED Light Source | Osram SOLERIQ S 19 |
| Start Time | Instant |
| Driver | Stand Alone (included) |
| Operating Position | Non - Swiveling Type |
| Dimming | On-Off / Triac / 0-10 V |
| Construction | Round |
| Mounting Type | Recessed |
| Heads | Single Head |
| Finish | White |
| Height | 2-5/8" |
| Diameter | 5-3/8" |
| Cut Out | 4-7/8" |
| Optics | Darklight Technology Black, Silver |
| IP Rating | - |
| Application Area | Outdoor Corridor, Bathroom, Eave. |

Beam Spread (Option)

| Wide Flood | 60° |
|------------|-------|
| ft | Ø |
| 3.0 | 3.15 |
| 9.0 | 9.45 |
| 15.0 | 15.75 |

Glim, a round shaped LED downlight made of aluminum die cast with high quality powder coated luminaire housing and optimum heat sink. Specular reflector & power grid /global connectors available with isolated LED Driver using Ultra bright OSRAM COB.